

Varenummer: 0111022

Beskrivelse: Seeger låsering G 9

Mål

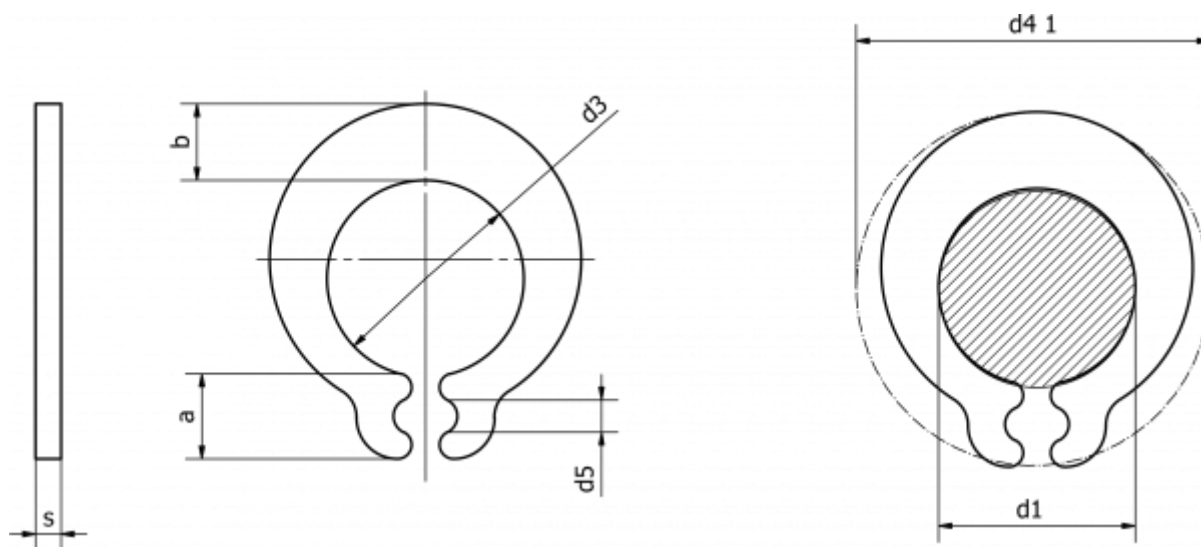

a max	= 4.7	n abl x 1000	= 46
b	= 3.3	s	= 1.20
Betegnelse	= G 9,0	Tang	= ZGG-2
d1	= 9.0	tol	= 0.090
d3	= 8.65	vægt kg/1000	= 0.808
d4 1	= 18.6		
d5 min	= 2.0		
Holdekraft N	= 230		